

## Cell 12 Adjustable (Continuum)

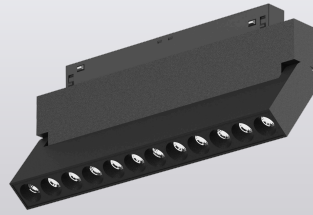

## ABOUT CONTINUUM

The Continuum Track System by Eterna Light combines flexibility, performance, and sleek design for professional-grade track lighting solutions. With the ability to incorporate a variety of custom inserts, designers can further tailor light distribution, effects, and functionality to meet the unique needs of any project.

Material	Extruded Aluminum
Finish	Powder Coating
Colour	White / Black
Beam Angle	30° / 40°
CRI	90+
Dimming	0-10V / DALI / CASAMBI

# Cell 12 Adjustable (Continuum)



Agency:

Project Name:

Project Type:

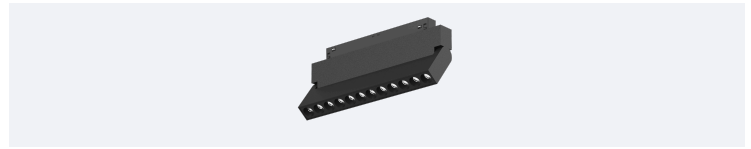

## Product Code

(Example: CONT-CELL12A-WH-STA-30D-30K-0-10V)

1 Product Name	2 Finish	3 Output	4 Beam Angle	5 CCT	6 Control
<b>CONT-CELL12A</b> - Continuum Cell 12 Adjustable	<b>WH</b> - White <b>BK</b> - Black	<b>STA</b> - L770/12W	<b>30D</b> - 30° (Middle) <b>40D</b> - 40° (Wide)	<b>27K</b> - 2700K <b>30K</b> - 3000K <b>40K</b> - 4000K	<b>0-10V</b> - 0/10V <b>DALI</b> - DALI <b>CASAMBI</b> - CASAMBI

## Order Code

<b>1</b>	<b>2</b>	<b>3</b>	<b>4</b>	<b>5</b>	<b>6</b>
----------	----------	----------	----------	----------	----------

Complete the order code by selecting one option per category.

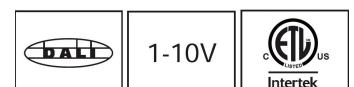

# Cell 12 Adjustable (Continuum)



## Product Details

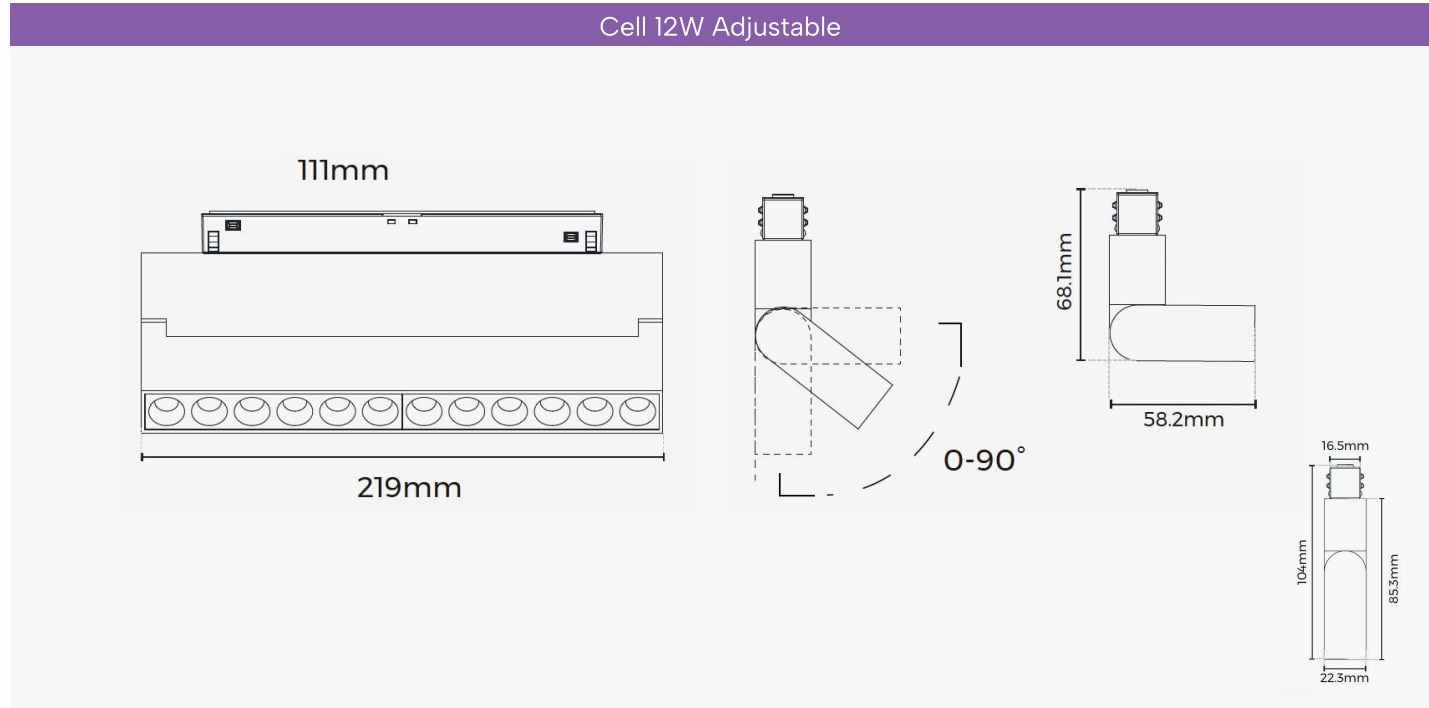

Product measurements are listed above for each configuration type.

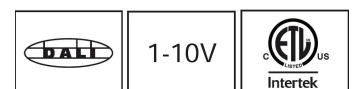

## Cell 12 Adjustable (Continuum)

### Photometrics

#### Cell 12W

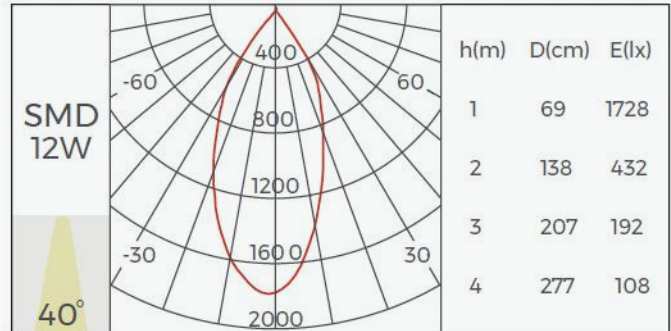
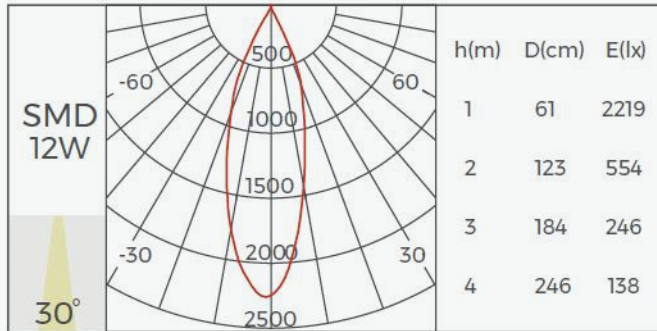

Performance values are based on independent photometric testing.

## Cell 12 Adjustable (Continuum)



### Technical Specifications

#### MATERIAL

Constructed from premium extruded aluminum, the Continuum Track System offers a perfect balance of durability, lightweight form, and thermal efficiency. Its precision-engineered profile ensures stable mounting, superior heat management, and long-lasting performance suitable for commercial, institutional, and hospitality environments.

#### TRIM OPTIONS & STYLE

Available in White or Black, the Continuum Series adapts effortlessly to any architectural setting. Track configurations include Slim, Standard, and Recessed profiles with a variety of inserts, offering flexibility for both aesthetic and functional lighting design.

#### LIGHT OUTPUT & PERFORMANCE

The Continuum System supports a broad range of high-performance LED modules designed for precision illumination. Whether for accent, general, or ambient lighting, its adaptable insert and track design enable seamless integration of diverse optics and outputs—delivering consistent, low-glare illumination with a UGR of <19.

#### COLOR TEMPERATURE & BEAM ANGLE

Supporting a full range of colour temperatures from 2700K to 4000K, Continuum provides the versatility to achieve warm, neutral, or cool lighting atmospheres. Modules can be specified with various beam spreads and optical controls, ensuring tailored light distribution for both focused and expansive environments.

#### DIMMING & ELECTRICAL

Continuum is compatible with modern dimming systems, supporting both 0–10V, DALI, and CASAMBI controls for precise light management and integration with advanced building systems. The system operates on standard 120V or universal 120–277V electrical inputs, ensuring reliable, energy-efficient, and flicker-free performance.

#### LIFE EXPECTANCY & OPERATING CONDITIONS

Engineered for endurance, Continuum-compatible LED modules maintain 70% of their initial output (L70) beyond 60,000 hours of operation. The system performs dependably in ambient temperatures ranging from -20°C to 40°C (-4°F to 104°F), ensuring consistent performance in varied indoor environments.

#### HOUSING & CERTIFICATIONS

Offered in Surface Mounted, Suspended, and Recessed configurations, the Continuum Track System accommodates both new construction and retrofit installations. All configurations are ETL listed and compliant with North American safety and performance standards.